

135-225

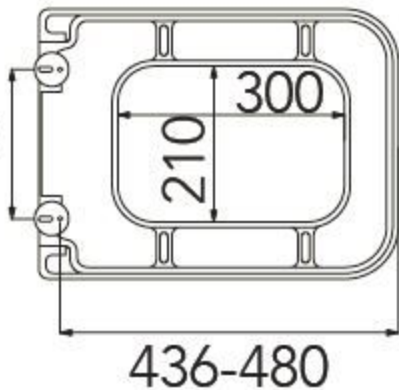

436-480

